

Die Sitzbank

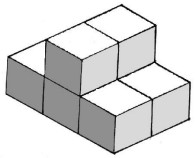

von vorne

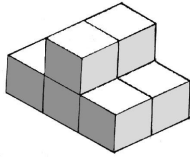

von hinten

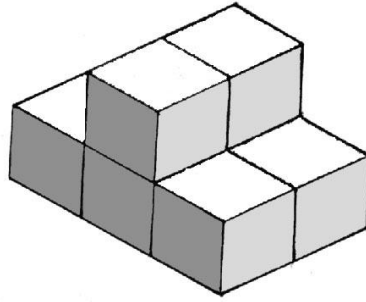

von vorne

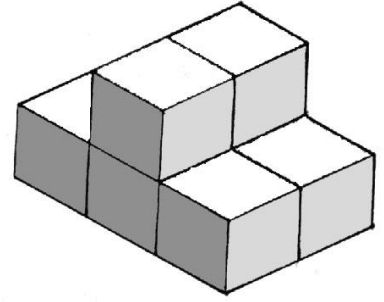

von hinten

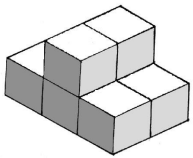

von vorne

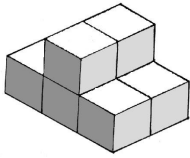

von hinten

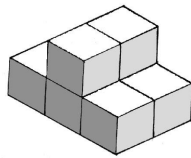

von vorne

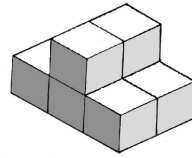

von hinten

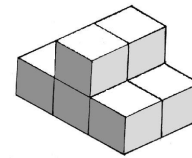

von vorne

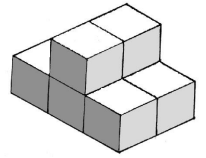

von hinten

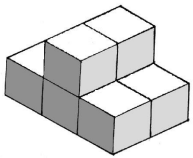

von vorne

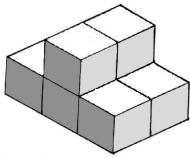

von hinten

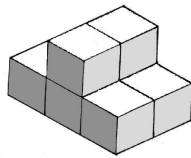

von vorne

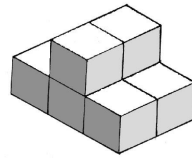

von hinten

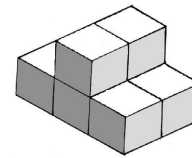

von vorne

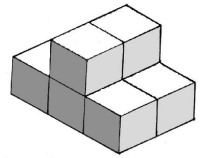

von hinten



Tipps, Tricks und geschickte Vorgehensweisen beim Bau der Sitzbank:

Der Quader

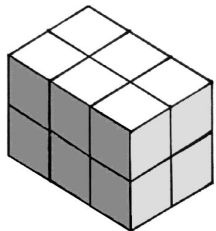

von vorne

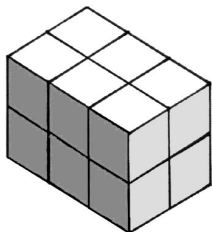

von hinten

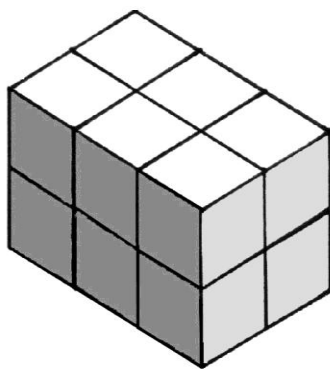

von vorne

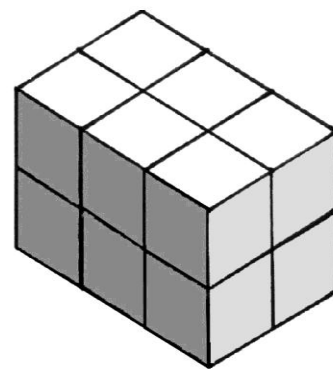

von hinten

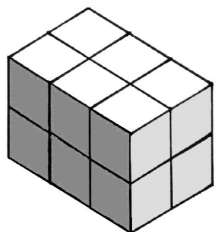

von vorne

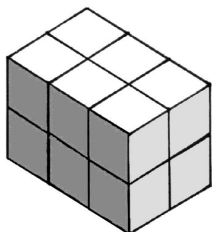

von hinten

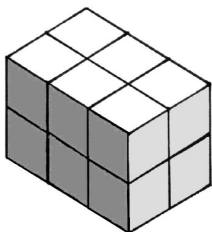

von vorne

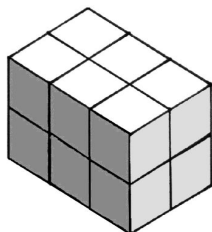

von hinten

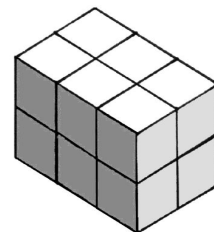

von vorne

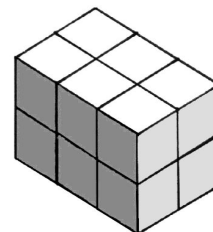

von hinten

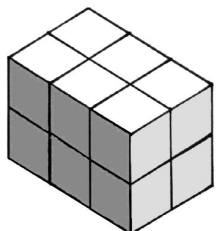

von vorne

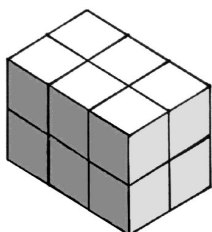

von hinten

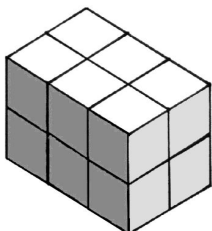

von vorne

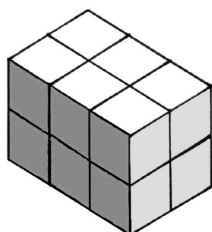

von hinten

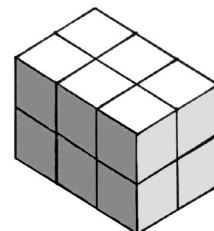

von vorne

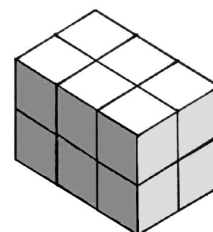

von hinten



Tipps, Tricks und geschickte Vorgehensweisen beim Bau des Quaders:

Das Sofa

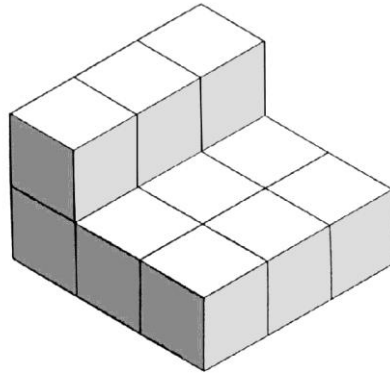
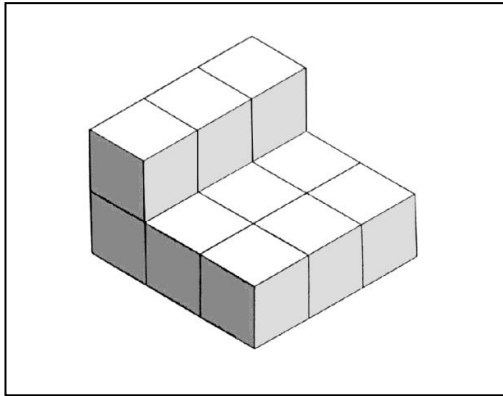

von vorne

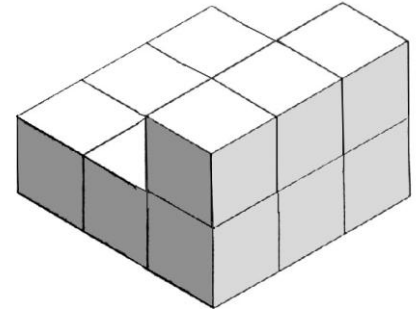

von hinten

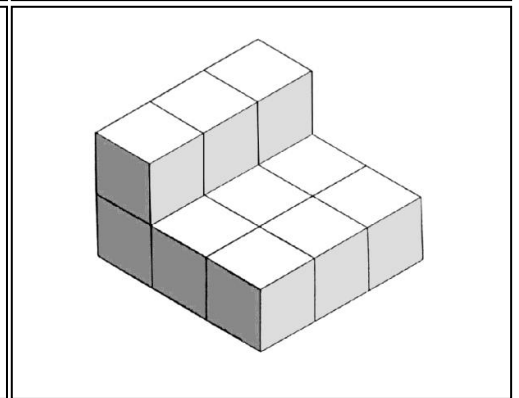
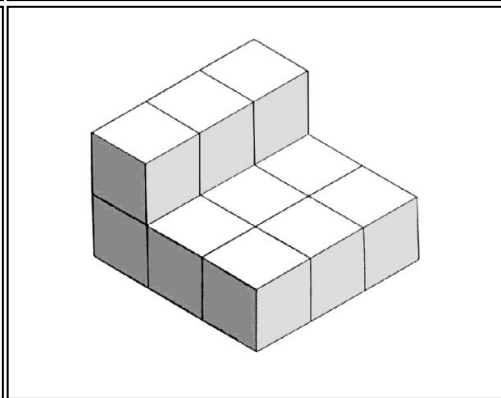
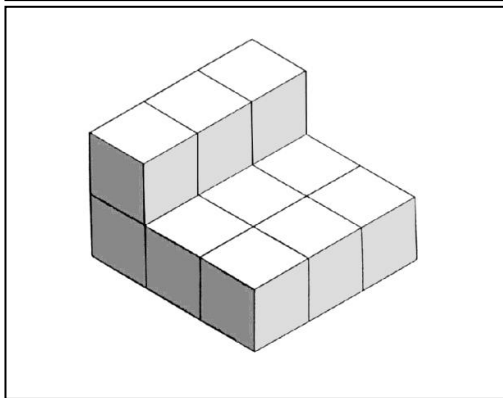
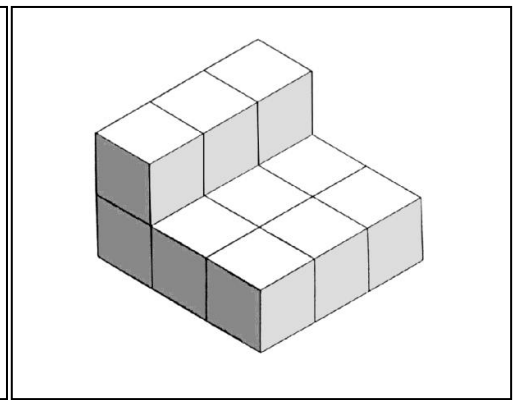
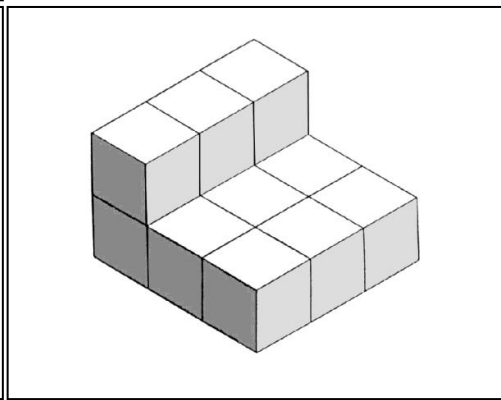
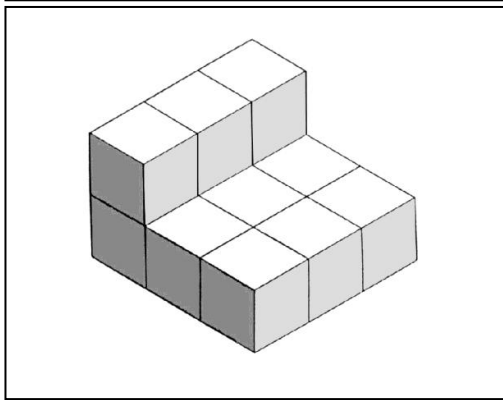

Tipps, Tricks und geschickte Vorgehensweisen beim Bau des Sofas:

Das Guckloch

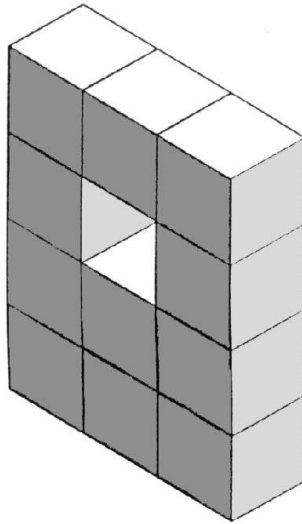
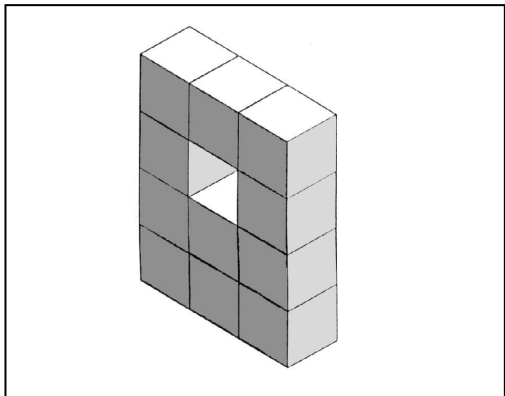

von vorne

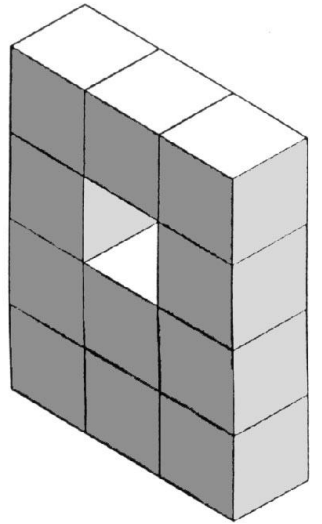

von hinten

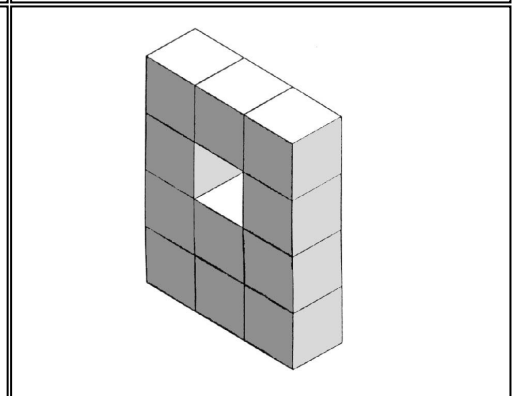
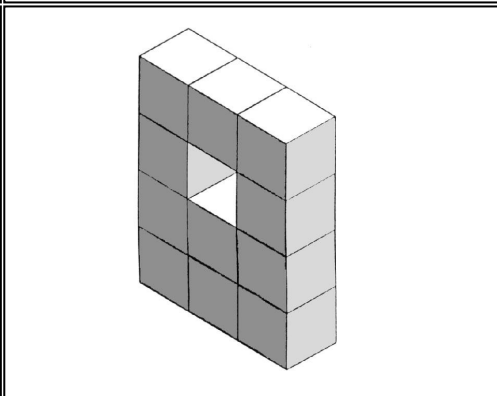
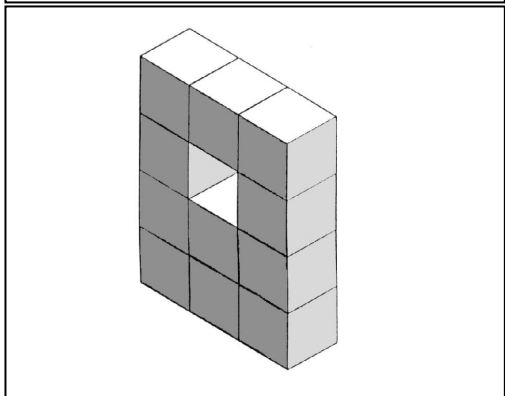
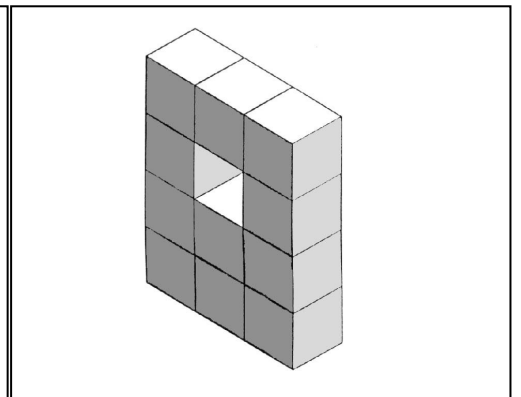
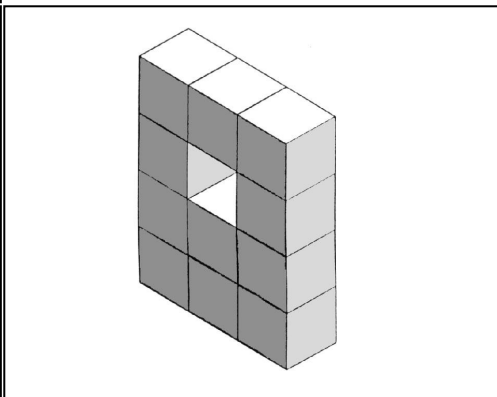
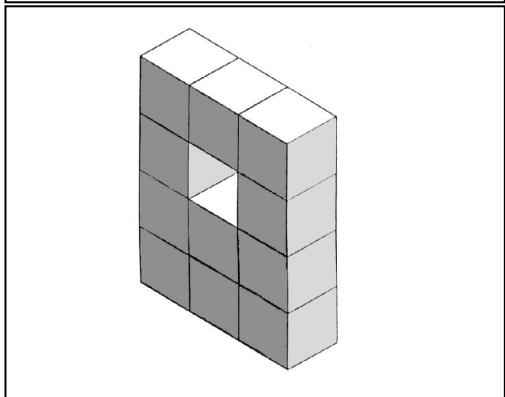

Tipps, Tricks und geschickte Vorgehensweisen beim Bau des Gucklochs:

Die Treppe

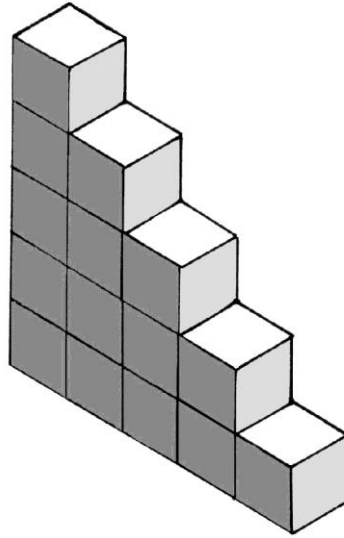
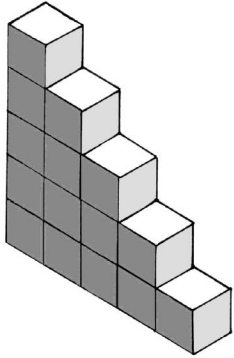

von vorne

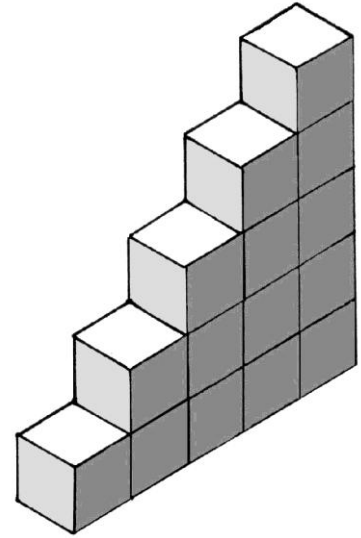

von hinten

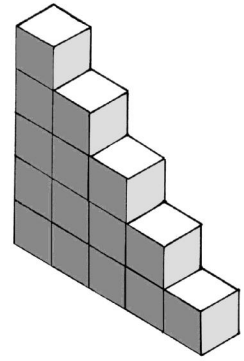
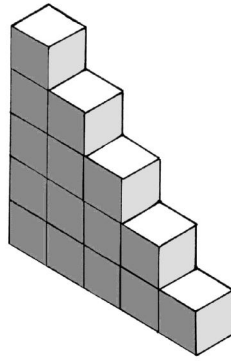
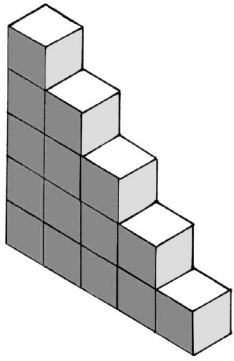
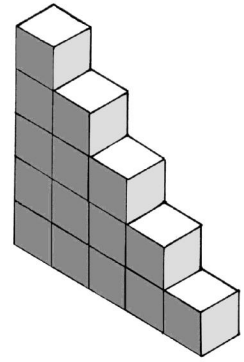
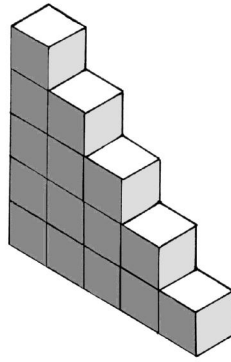
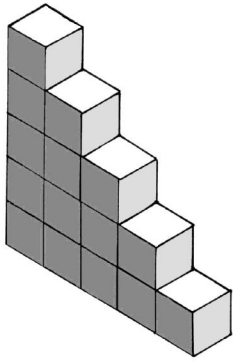

Tipps, Tricks und geschickte Vorgehensweisen beim Bau der Treppe:

Der Turm

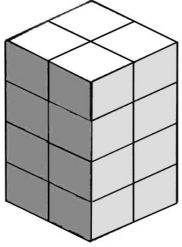

von vorne

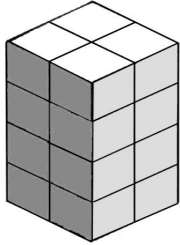

von hinten

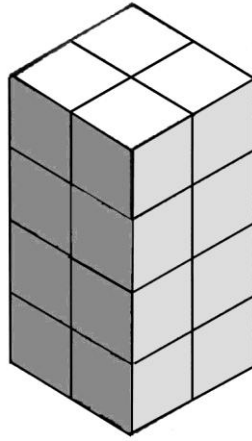

von vorne

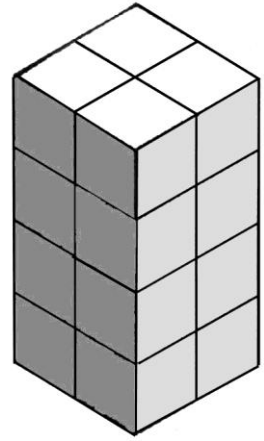

von hinten

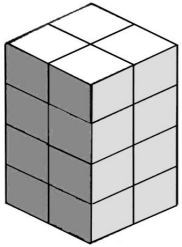

von vorne

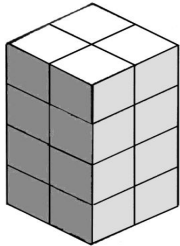

von hinten

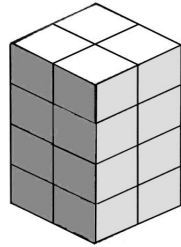

von vorne

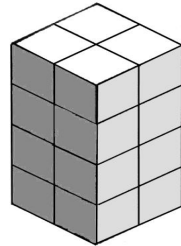

von hinten

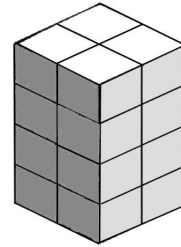

von vorne

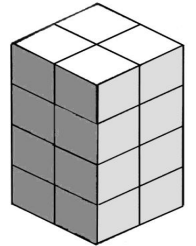

von hinten

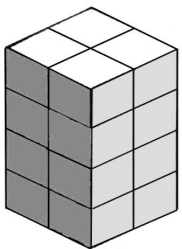

von vorne

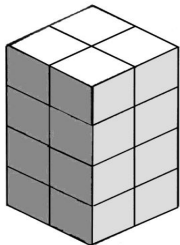

von hinten

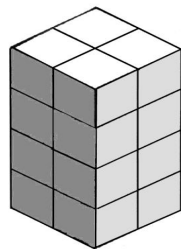

von vorne

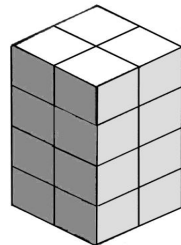

von hinten

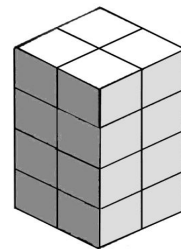

von vorne

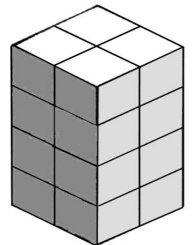

von hinten



Tipps, Tricks und geschickte Vorgehensweisen beim Bau des Turms:

Die Zimmerecke

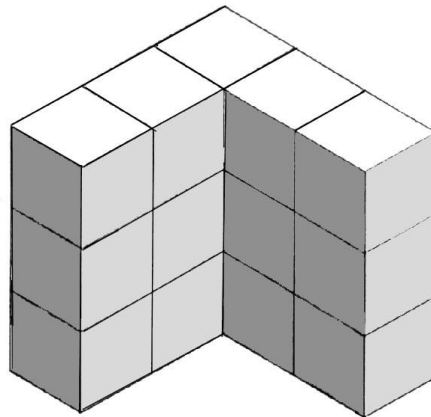
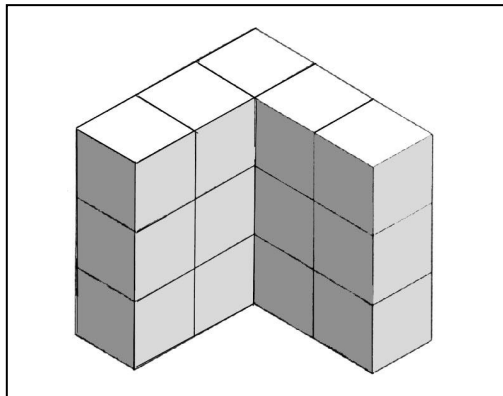

von vorne

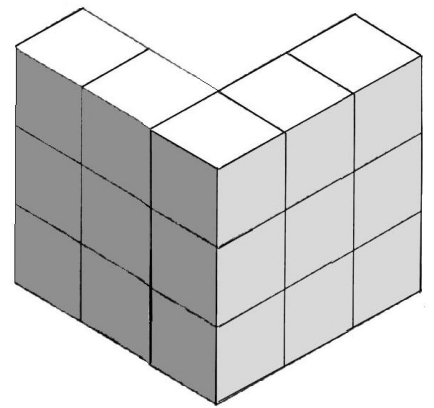

von hinten

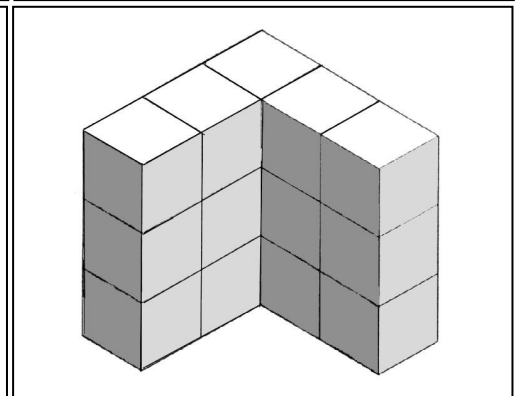
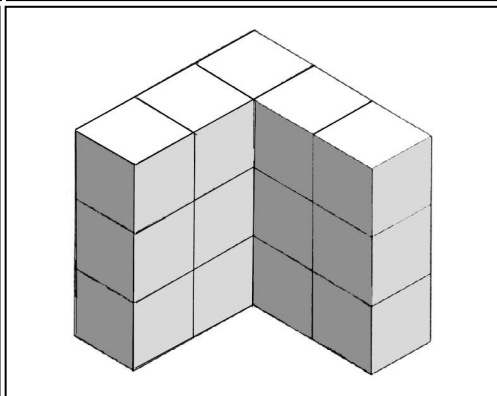
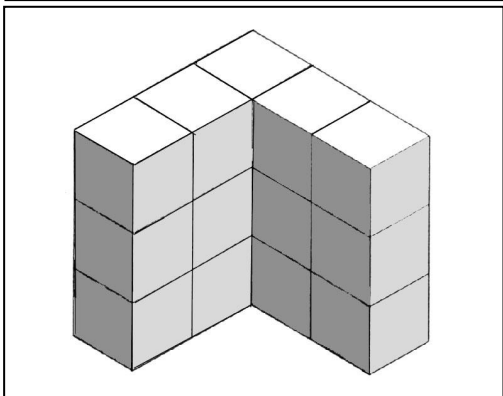
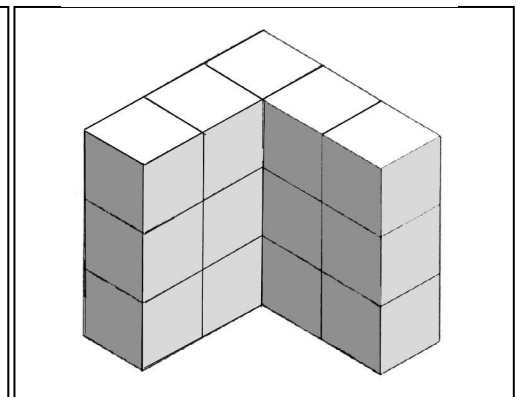
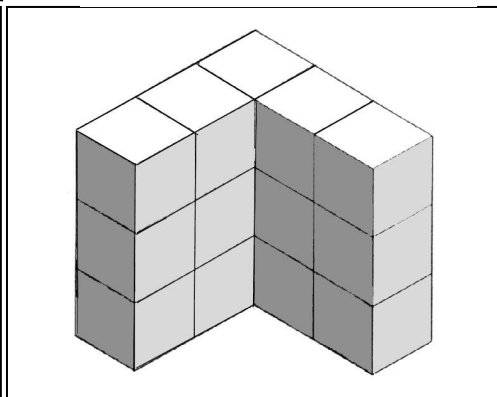
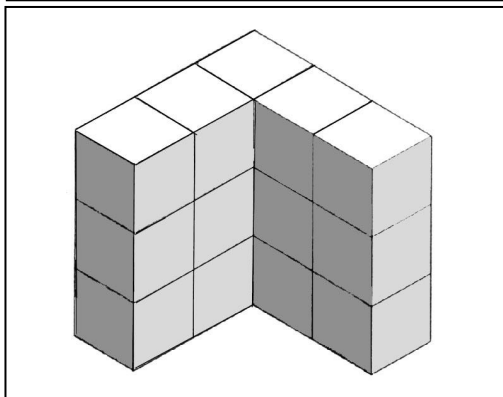

Tipps, Tricks und geschickte Vorgehensweisen beim Bau der Zimmerecke:

Der Giebel

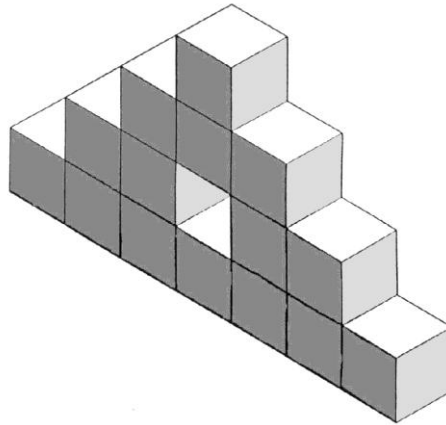
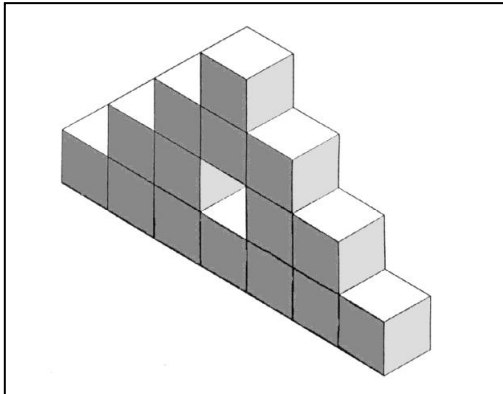

von vorne

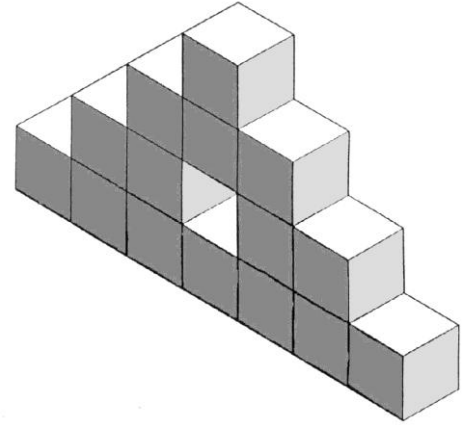

von hinten

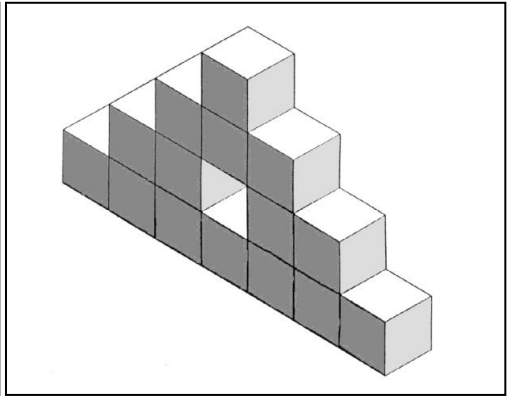
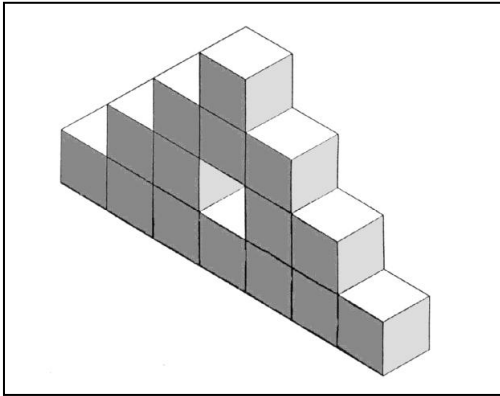
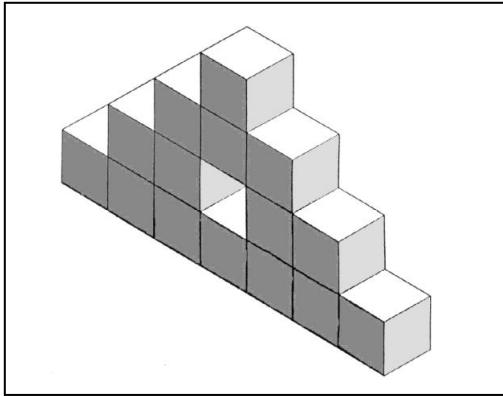
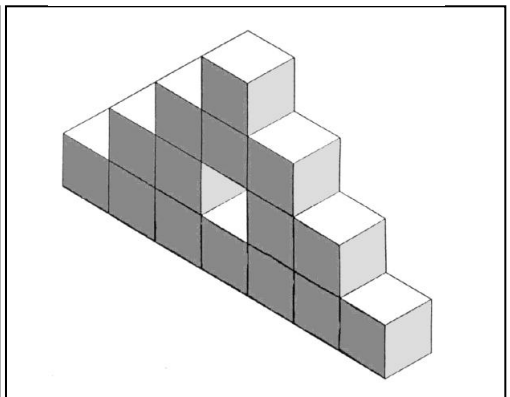
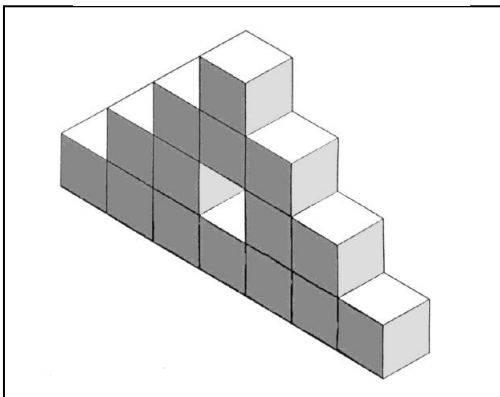
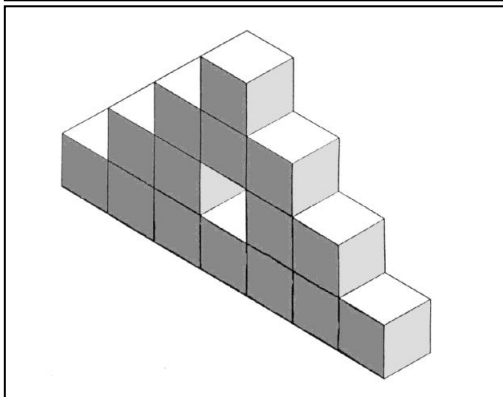

Tipps, Tricks und geschickte Vorgehensweisen beim Bau des Giebels:

Die Mauer

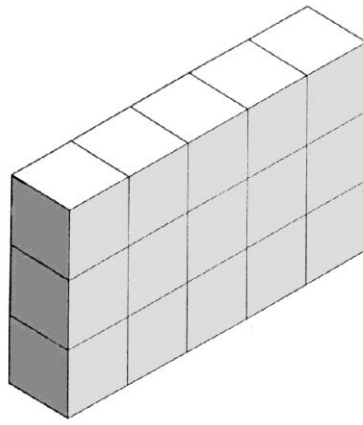
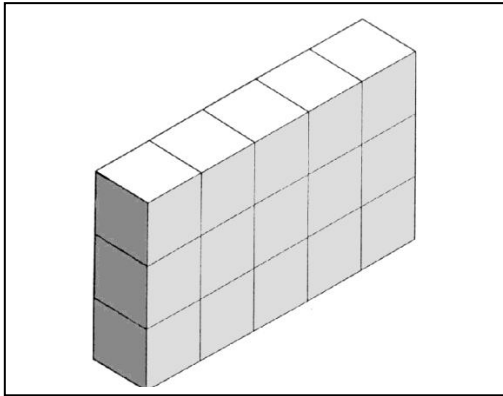

von vorne

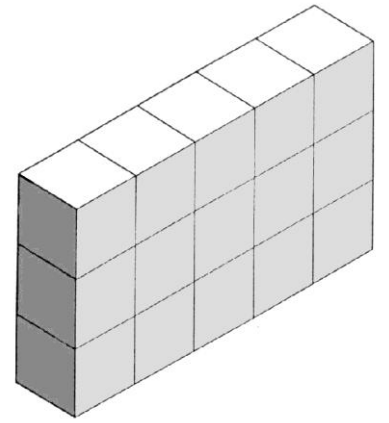

von hinten

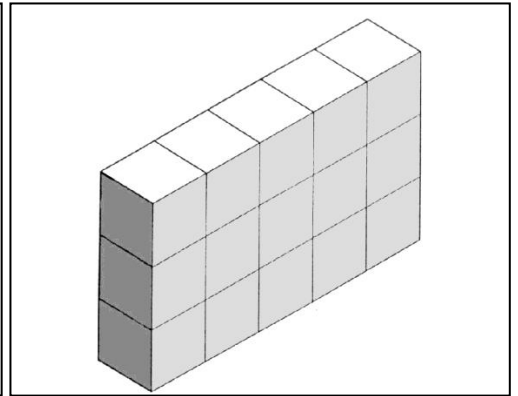
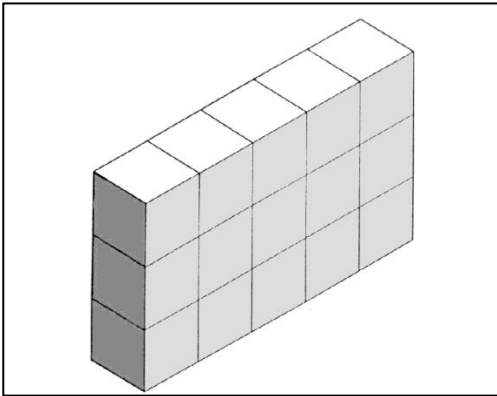
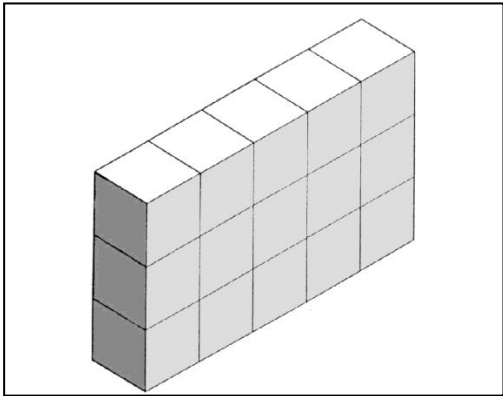
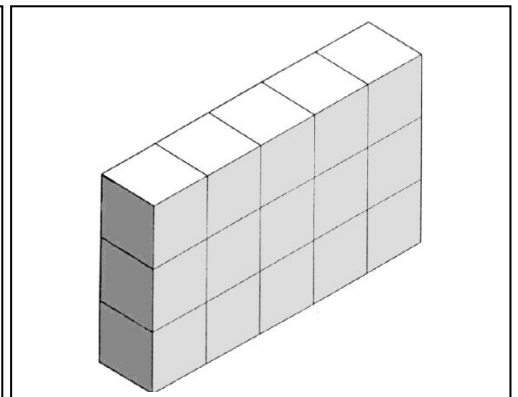
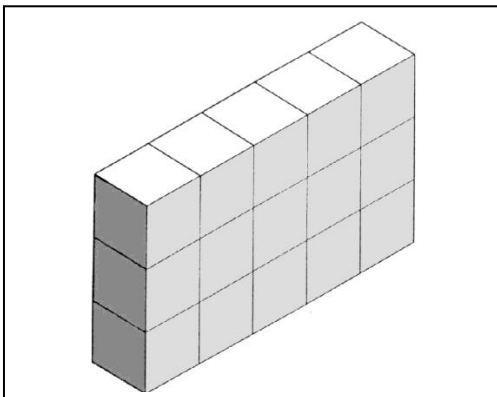
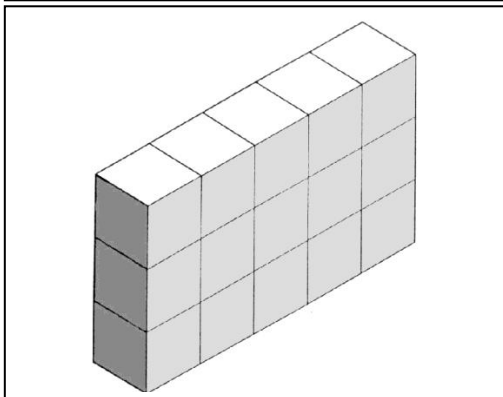

Tipps, Tricks und geschickte Vorgehensweisen beim Bau der Mauer:

Der hohe Turm

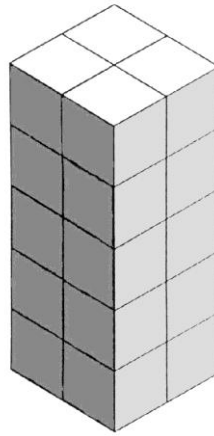

von vorne

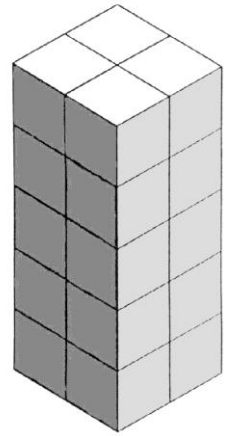

von hinten

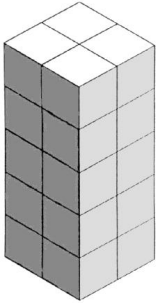

von vorne

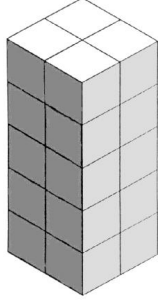

von hinten

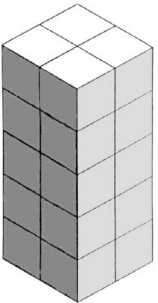

von vorne

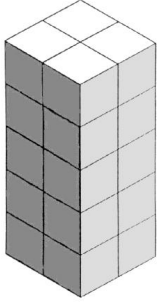

von hinten

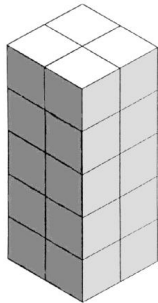

von vorne

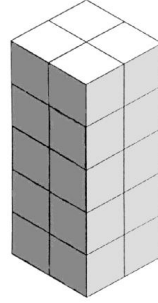

von hinten

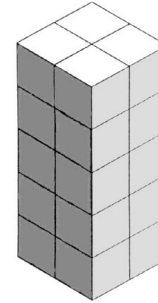

von vorne

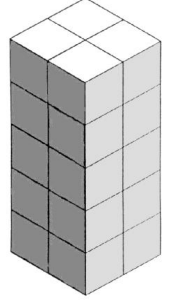

von hinten

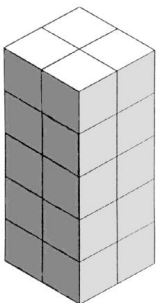

von vorne

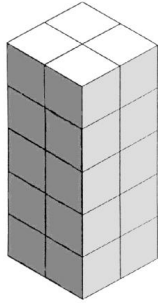

von hinten

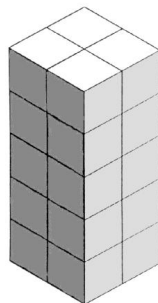

von vorne

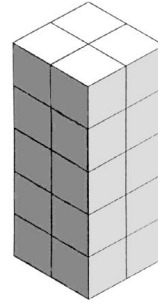

von hinten

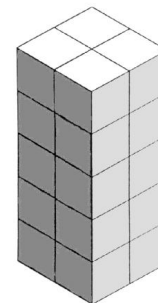

von vorne

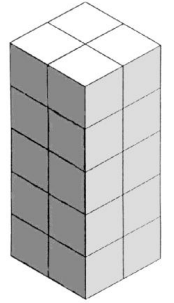

von hinten



Tipps, Tricks und geschickte Vorgehensweisen beim Bau des hohen Turms: